

USE'R MANUAL

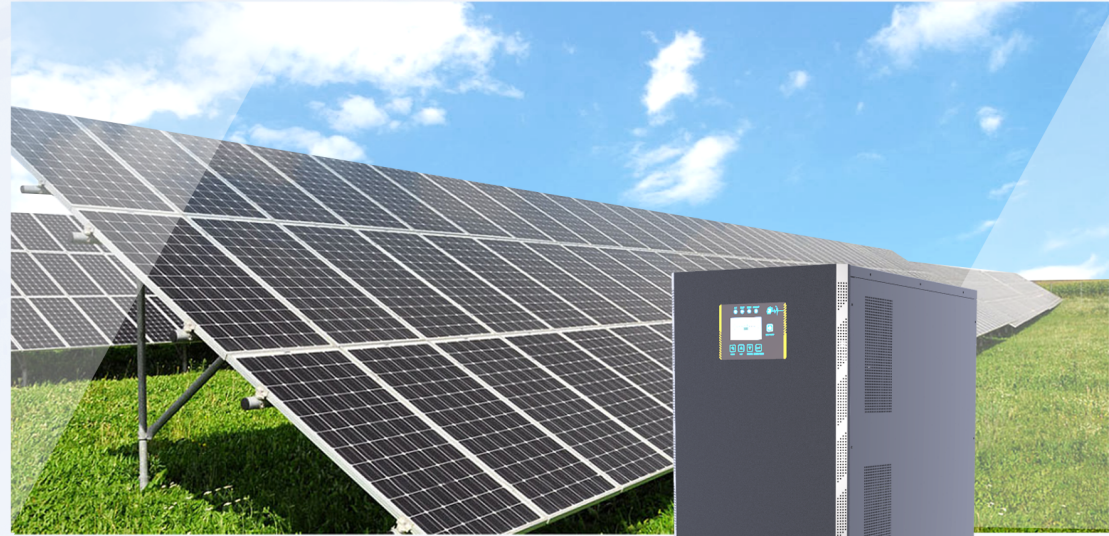

# SOLAR INVERTER

PURE SINE WAVE INVERTER

TD SERIES

# Catalogue

---

1. Safety Precautions .....	01
2. Product Appearance .....	03
3. LCD Panel Display .....	03
4. Unpacking Inspection .....	05
5. Installation Requirements .....	05
6. Inverter Circuit Diagram .....	06
7. LCD Panel Operation .....	08
8. Troubleshooting .....	14
9. Protection And Cleaning .....	15
10. Disassembly .....	15
11. Technical Data Sheet .....	16

# 1. Safety Precautions



## Operational Safety

1. Please read “Safety Precautions” carefully before using this product to ensure correct and safe use. Please keep this manual in a safe place.
2. When operating, please pay attention to all warning signs and operate as required.
3. Do not use the device in direct sunlight, rain or moisture environment.
4. This equipment cannot be installed near heat source areas, or near electric heaters, furnaces, etc.
5. When placing the inverter, keep a safe distance around it, ensure ventilation and heat dissipation and product maintenance. Please refer to this manual when installing.
6. When cleaning, use a dry, non-conductive item to wipe.
7. In the event of a fire, please use a dry power fire extinguisher for fire fighting. Do not use liquid fire extinguishers.
8. Please consider the position-to-machine and battery pack load-bearing capacity before installation.
9. Before using the device, please ensure that the load power matches the rated power of the inverter and the battery specifications.

## Prohibited Matter

1. There is high voltage inside the power supply equipment, not the company or a technician who is not authorized by the company, Do not open the lid without authorization, otherwise there is a danger of electric shock and loss of warranty.
2. Before applying to the following load equipment, please discuss with the dealer in advance; its application, setup, management and maintenance must have special considerations and design:
  - A. Precision industrial, scientific and medical instruments and equipment;
  - B. Elevators and other equipment that may endanger personal safety;
  - C. Starting a load device with a large current and generating negative work;
3. Do not place the battery in a fire to avoid explosion.

## Electrical Safety

1. Before powering up, please confirm that it is properly grounded and check the correctness of the distribution line and battery polarity.
2. The battery protection device must be equipped with an overcurrent protection circuit breaker of the rated specification.
3. When the inverter needs to be moved or re-wired, it must be ensured that the inverter is completely shut down and the input breaker and battery switch are disconnected, otherwise the output may still be charged and there is a danger of electric shock.
4. Before connecting the inverter, the client must install a four-pole overcurrent protection device with rated value in the power distribution system to disconnect all input lines to prevent electric shock.

# 1. Safety Precautions



## Battery Safety

1. The life of the battery is shortened as the ambient temperature increases. Regular battery replacement ensures that the inverter is working properly and that sufficient backup time is guaranteed.
2. Battery replacement and maintenance should only be carried out by authorized personnel with battery expertise. The same type and model of battery must be used and must be the same quantity.
3. There is a danger of electric shock and short current in the battery. To avoid electric shock and injury, please observe the following warnings when replacing the battery:
  - A. Do not wear watches, rings or similar metal objects;
  - B. Use insulated tools;
  - C. Wear rubber shoes and gloves;
  - D. Do not place metal tools or similar metal parts on the battery;
  - E. Disconnect the load connected to the battery before removing the battery connection terminal.
4. It is strictly forbidden to expose the battery to fire to avoid explosion and endanger personal safety.
5. Non-professionals should not open or damage the battery, because the electrolyte in the battery contains dangerous substances such as strong acid, which can cause damage to the skin and eyes. If you accidentally come into contact with the electrolyte, immediately wash it with plenty of water and go to the hospital for examination.
6. Do not short-circuit the positive and negative terminals of the battery. Over-current protection must be installed in the battery box to prevent fire or electric shock.

## Use And Maintenance

1. The use environment and storage methods have an impact on the service life and reliability of this product. Therefore, please be careful not to use it in the following working environments:
  - A. High, low temperature and humidity places that exceed the technical specifications (temperature 0-55 °C, relative humidity 0-95%, No condensation);
  - B. Locations that are subject to vibration and are subject to collision;
  - C. Locations with metallic dust, corrosive substances, salt and flammable gases.
2. If not used for a long time, the inverter (without battery) must be stored in a dry environment with a storage temperature range of 0-55 °C. Before the inverter is turned on, the ambient temperature must be warmed to above 0 °C for more than 2 hours.
3. Please keep the inlet and exhaust holes open. Poor ventilation of the inlet and exhaust holes can cause the temperature inside the inverter to rise, shortening the life of components in the machine, which will affect the life of the machine.
4. When the battery is not used for a long time, the battery needs to be charged once if it has not been charged for three consecutive months.

## 2.Product Appearance

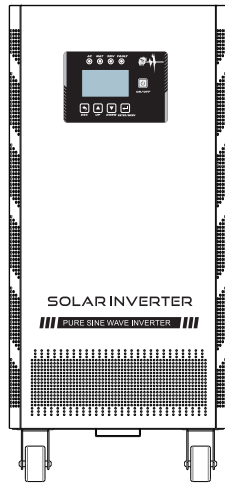

TD-10348/TD-10396

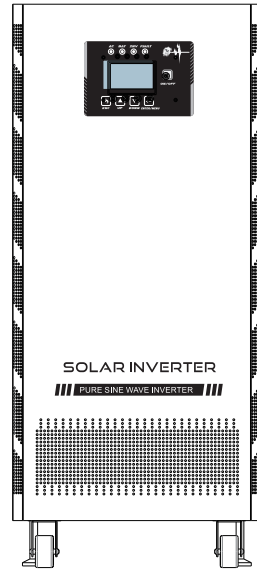

TD-153192/TD-203192

### 2.1.Dimension

Model	TD-10348/TD-10396	TD-153192/TD-203192
Dimension	L*W*H 540x300x663mm	L*W*H 680x385x870mm

## 3.LCD Panel Display



LCD screen is an interface used for man-machine interaction, which can be used for visual operation through LCD screen, which provides a friendly interface for functions such as turn on, turn off, state display, fault alarm, parameter setting, and so on. After installation, the user can complete all operations through the LCD screen. The LCD screen includes three parts: status indicator, LCD display screen, and navigation key. The following table describes the status indicator and the navigation button respectively.

## 3.LCD Panel Display

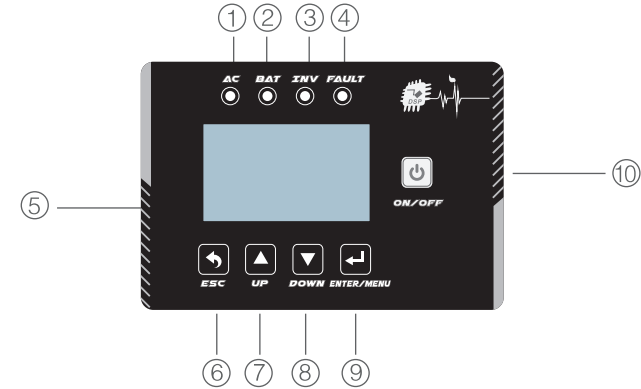

### • Status Indicator

Identification	Indicator light name	Status
①	AC	AC Normal
②	Battery	Flash:Charging;Long bright:full
③	Inverter	Battery inverter power supply
④	Fault/Warning	Warning/work abnormal

### • LCD Display——⑤: Detailed display information

### • Navigation keys: selection, opening, obtaining information, modifying system parameters, etc.

Identification	Navigation keys	Name	Function
⑥		Return	Return to the previous interface menu or exit the settings interface (do not save the settings)
⑦		UP	Page turning; switching options; adding settings value
⑧		Down	Page turning; switching options; minus setting values
⑨		Confirm	Press and hold for 5 seconds to enter the setting interface; short press to confirm save or set to enter the setting submenu
⑩		Turn On/Off	Turn on and shutdown operation



## 4.Unpacking Inspection



1. Open the Package ,it should be include:

- 1) One unit Inverter
- 2) Communication Wire(optional)
- 3) External display (optional)
- 4) User manual

2. Before opening the inverter package, please check if the inverter is damaged during transportation. If it is found damaged or missing parts, do not turn it on. Contact the carrier or dealer immediately.

## 5.Installation Requirements



- The wall on which the inverter is mounted must be sturdy and can withstand the weight of the inverter for a long time. (Please refer to the instruction manual for the weight of the inverter).
- The installation location must match the size of the inverter.
- Do not install the inverter on a building constructed of flammable or heat-resistant materials.
- Install the inverter in a head-up orientation for easy inspection of the LCD display and maintenance work.
- It is not recommended to expose the inverter directly to strong sunlight.
- The humidity of the installation environment should be between 0 and 95% (non-condensing).
- The ambient temperature around the inverter should be between 0 °C and 55 °C.
- The inverter can be mounted on a plane that is tilted vertically or backwards as shown:

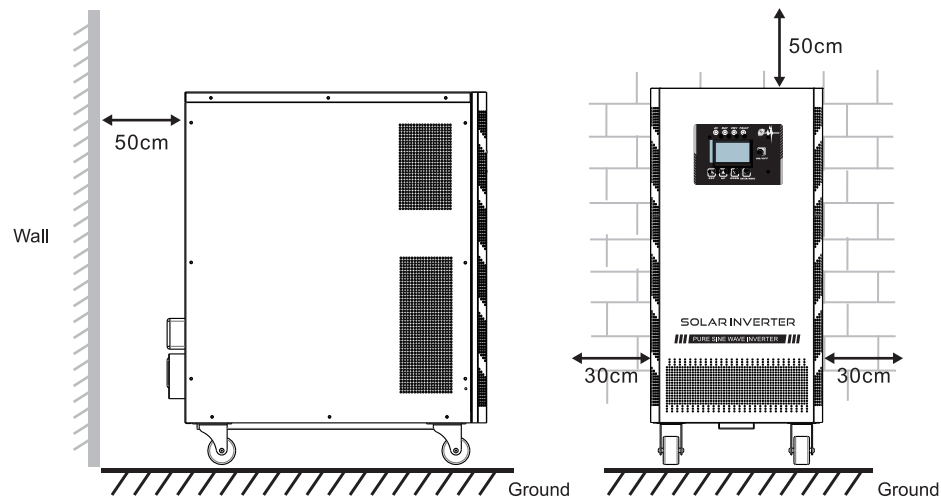

## 6.Inverter Circuit Diagram



TD-10348/TD-10396

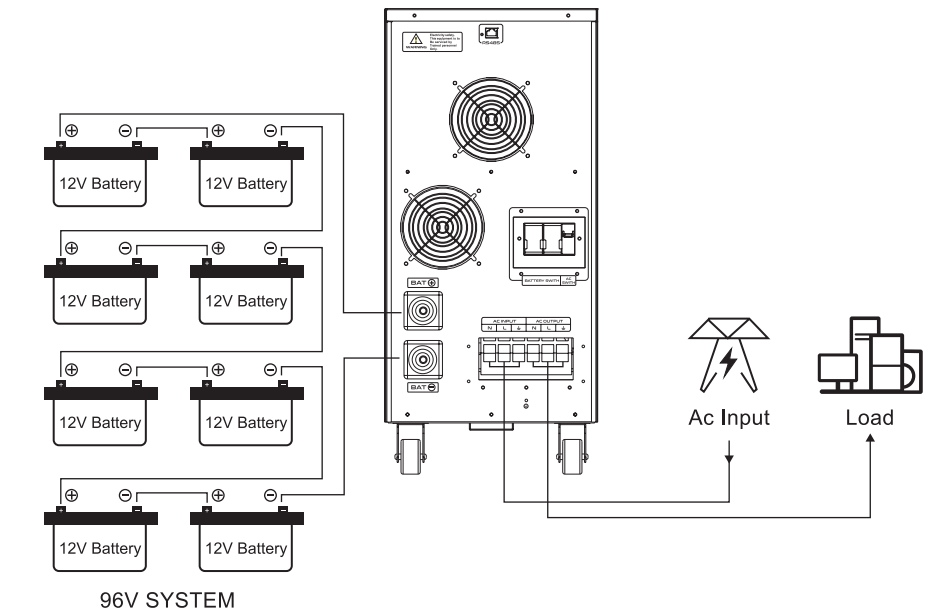
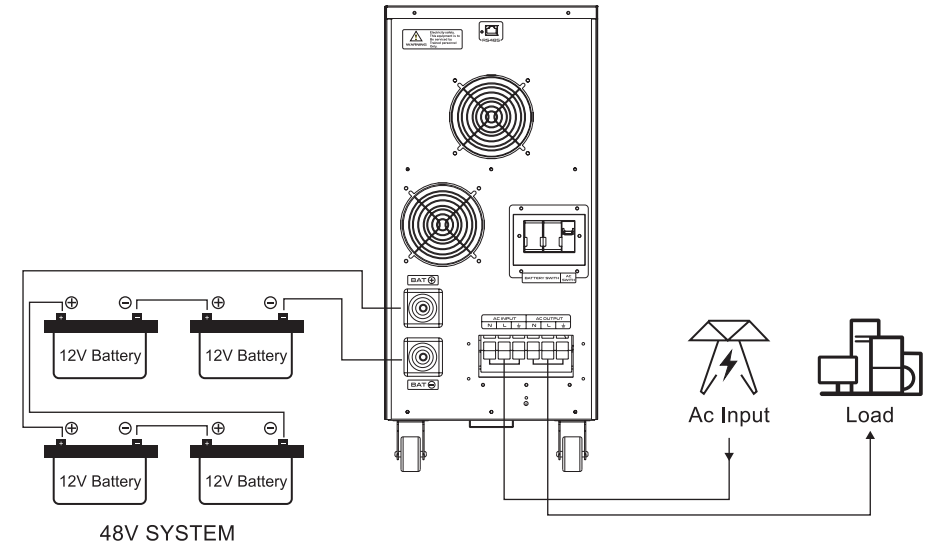

## 6. Inverter Circuit Diagram



TD-10348/TD-10396

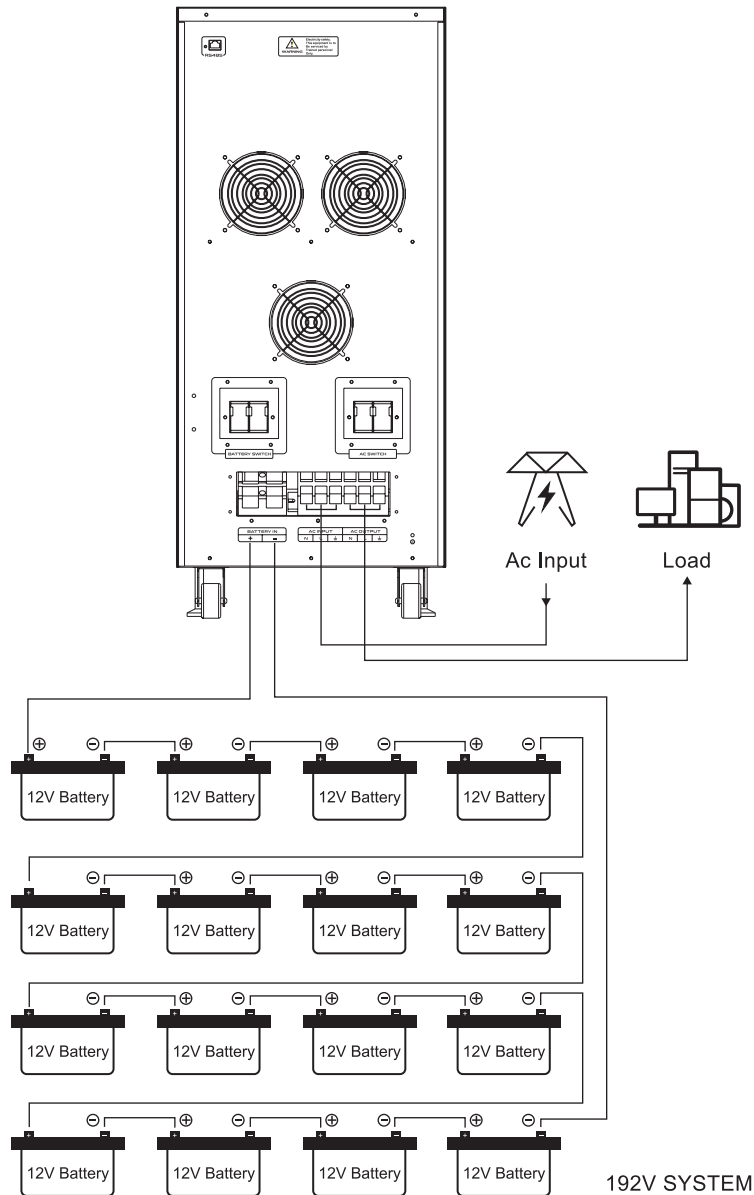

## 6. Inverter Circuit Diagram



The machine with relatively high power is connected to the mains input and load output through the terminal block. The load output is output in addition to the terminal block mode. Some models provide socket output, and the output current cannot exceed 10A.

### 6.3. AC input and output load connection

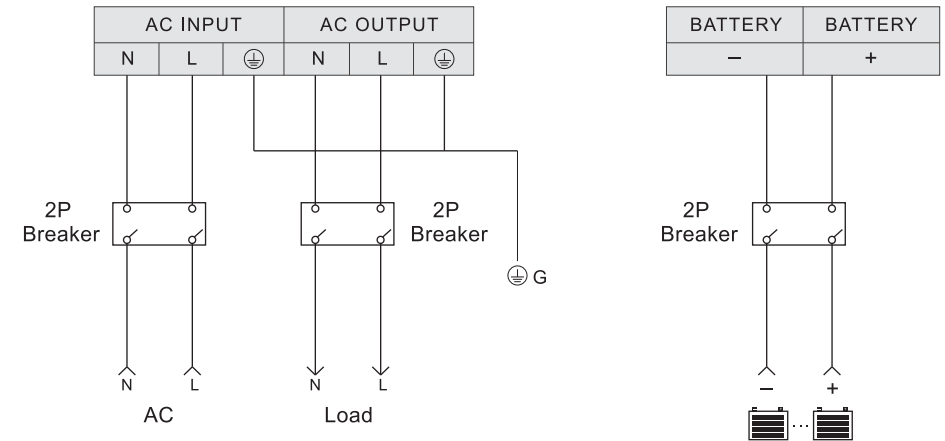

## 7. LCD Panel Operation



### 7.1. The main interface description is as shown

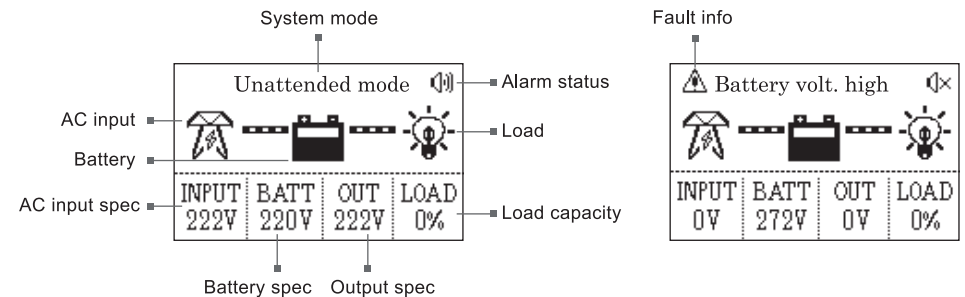

## 7.LCD Panel Operation



7.2. In the unattended mode, the battery voltage will be too low to enter the system standby.

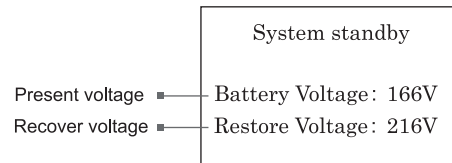

7.3. In the default main interface, press the up (▲) or down (▼) button to scroll through the pages. Under the main page, long press the back and down keys to restore the factory settings.

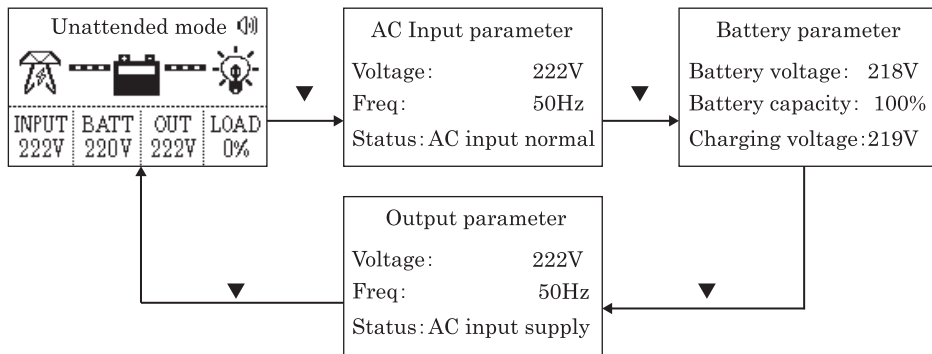

7.4. In the default main interface, long press the confirm (↵) button for five seconds to enter the setup menu, press the (▼) button to scroll through the submenus. Set to battery priority mode, the default charge is off, you need to charge to the current settings page.

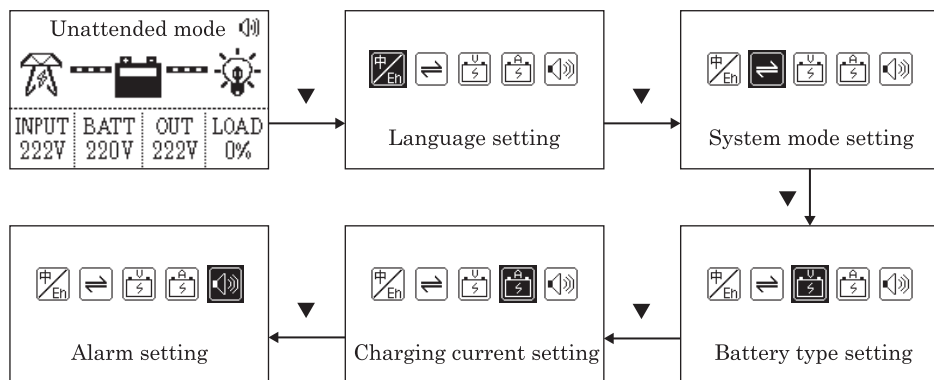

## 7.LCD Panel Operation



7.5. Language setting

In the default main interface, long press the confirm (↵) button for five seconds to enter the setup menu, press the (▼) button to select the language setting and press the confirm (↵) button to confirm, press the return (↩) button to return to the menu or wait after the pop-up is successful. 2 seconds automatically returns to the menu.

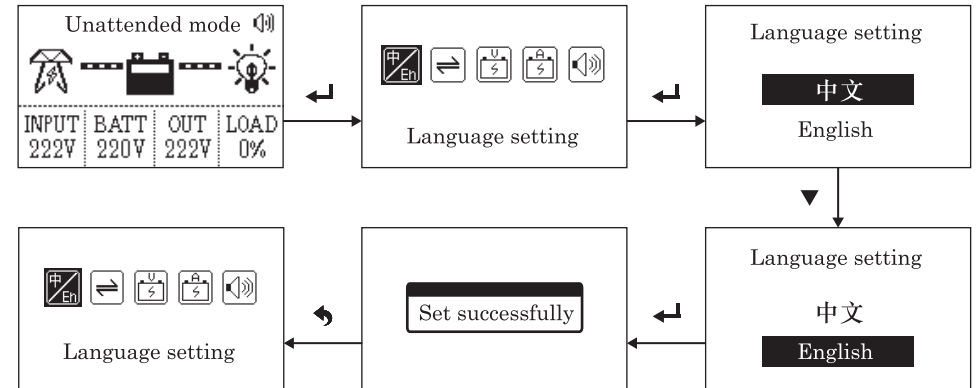

7.6. Charging current setting

In the default main interface, long press the confirm (↵) button for five seconds to enter the setup menu, press the (▼) button to select the charging current setting and press the confirm (↵) button to confirm, press the (▼) button to modify the value, confirm the value and press to confirm (↵) button, press the return (↩) button to return to the menu after the pop-up setting is successful or wait for 2 seconds to automatically return to the menu.

(Note: setting the value to 0% will turn off the charging function)

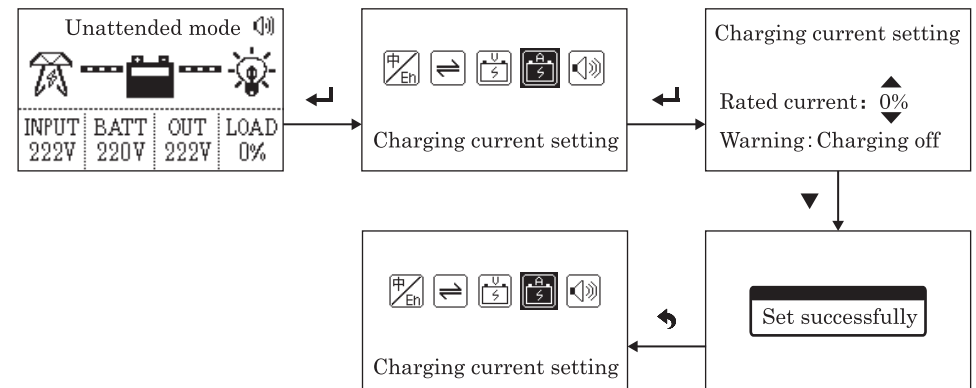

## 7.LCD Panel Operation



### 7.7. System mode setting

In the default main interface, long press the confirm ( ) button for five seconds to enter the setup menu, press the ( ) button to select the system mode setting and press the confirm ( ) button to confirm, enter the mode selection press ( ) button to select the option, pop-up settings After success, press the Back ( ) button to return to the menu or wait for 2 seconds to automatically return to the menu.

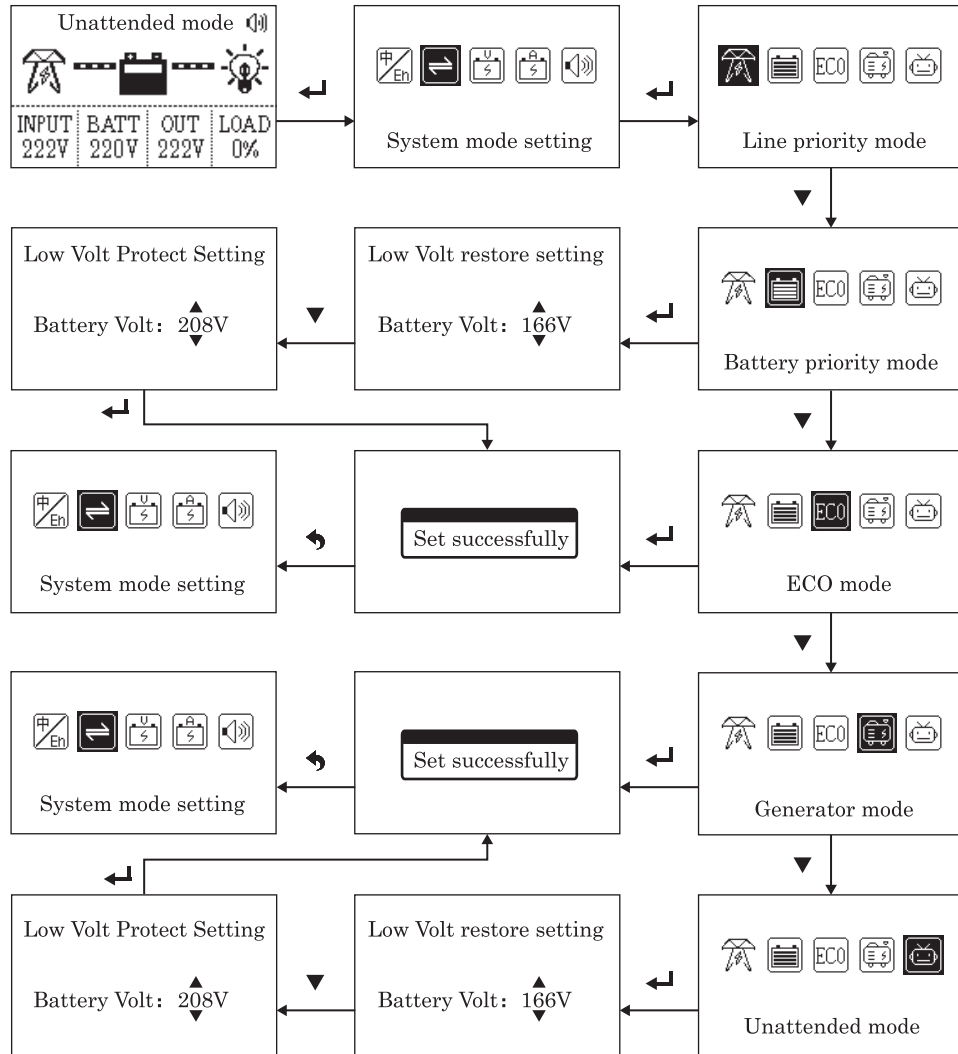

## 7.LCD Panel Operation



### 7.8. Battery type setting

In the default main interface, the long press confirm ( ) key 5 seconds into the settings menu, press ( ) button to select battery type settings and then press confirm ( ) key confirmation, enter mode select press ( ) key selection option, Press return ( ) to return to menu or wait for 2 seconds to automatically return to menu.

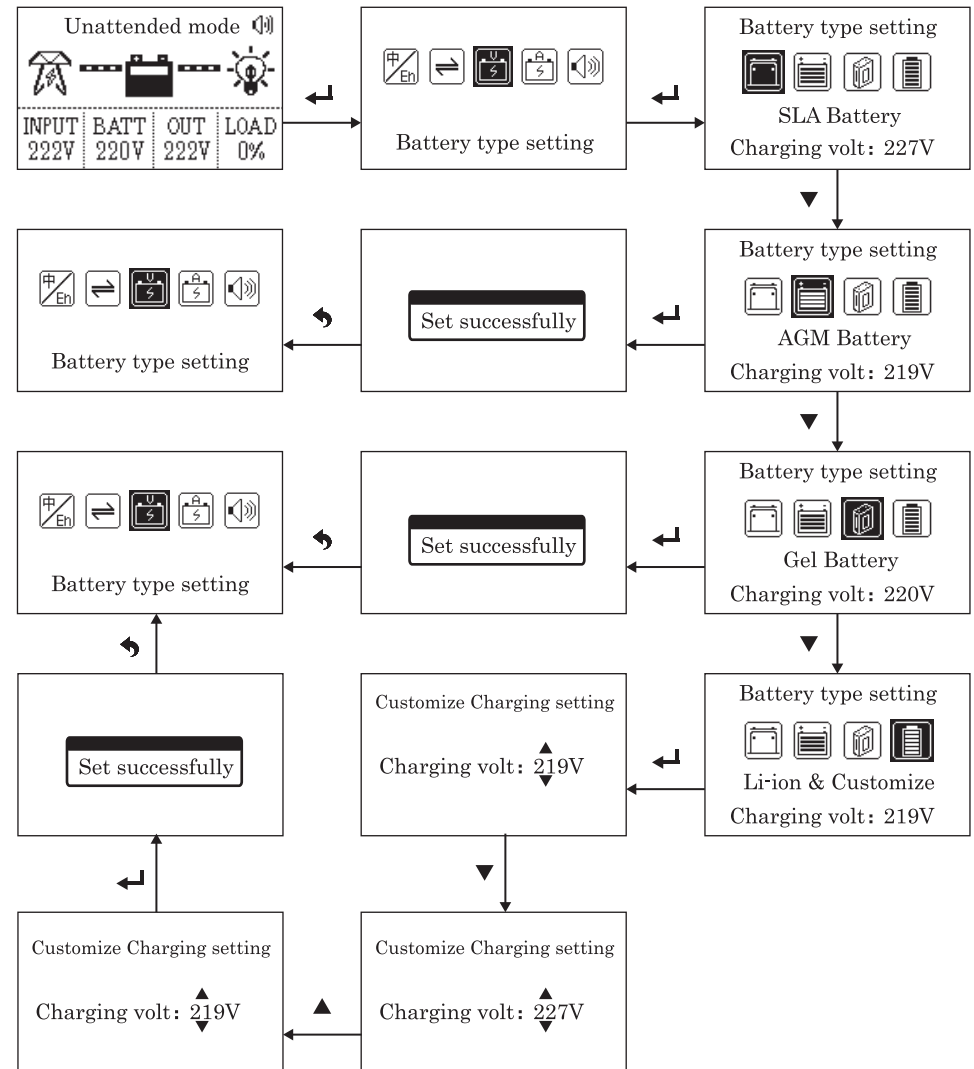







## 7.LCD Panel Operation



### 6.9. Alarm setting

In the default main interface, long press the confirm (  ) button for five seconds to enter the setup menu, press the (  ) button to select the alarm tone setting and press the confirm (  ) button to confirm, press the return (  ) button to return to the menu or Wait 2 seconds to automatically return to the menu.

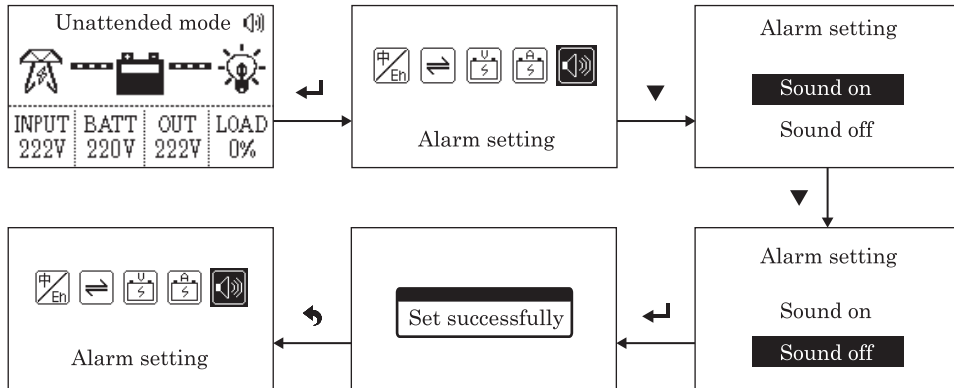

## 8.Troubleshooting



When the inverter is not working properly, we recommend the following solutions to eliminate common faults. The table below helps the technician understand the problem and take action.

Appearance	Possible Reason	Exclusion Method
No AC Input	1.Recoverable fuse pop up 2.Beyond the normal range	1.Check the load without abnormality and press the pop-up again. 2.Waiting for AC input to return to normal
Connection terminal temperature rise abnormally	1.Poor contact or loose	1. Retighten
Turn on the load device to automatically shut down	1.The battery is low 2.Overload 3.The battery cable is too small	1.Check the battery, recharge 2.Reduce the load 3.Replace the wires with sufficient cross-sectional area
Unable to start	1. AC input and battery are not connected correctly. 2. The battery voltage or specification does not match.	1.Check all the cables 2.Check the battery
Power on alarm	1.The battery is low 2.Overload	1.Check the battery, recharge 2.Reduce the load
Buzzer sounds 2 times	1.The machine temperature is too high	1.Check if the fan and cooling holes are blocked. 2.Overload
Fan stalls or slows down	1.Fan speed 2.The fan is stuck	1.The normal phenomenon, the fan is the intelligent control method 2.Check the fan

## 9. Protection And Cleaning



### 9.1 Check the heat dissipation

Check the environment around the inverter to eliminate the clogging of the vents. Cleaning the device will improve the heat dissipation of the inverter.

### 9.2 Cleaning the inverter

Turn off the AC circuit breaker, DC switch, and wait until the inverter is turned off. You can wipe the inverter with non-conductive items. Do not use water or any cleaning agent (such as solvent or abrasive).

### 9.3 Check connection

Regularly check the cable and switch for damage or abnormal heat; if there is any damage to the cable and DC switch, please contact a professional staff for inspection.

## 10. Disassembly



### 10.1 Disassemble the inverter

- Let the inverter be powered off.
- Remove all cables connected to the inverter.
- Unscrew all cable connectors.
- Carefully remove the inverter.

### 10.2 Inverter packaging

Whenever possible, replace the inverter with the original box and fasten it with the bag. If you can't find the original box, you can also use a box of the same size to ensure that it is the right size and can withstand the weight of the inverter.

### 10.3 Inverter processing



Do not dispose of the obsolete inverter or its accessories as domestic waste. The disposal methods of discarded electrical and electronic products refer to the regulations on the management of waste electrical and electronic recycling.

## 11. Technical Data Sheet



Model		TD-10348	TD-10396	TD-153192	TD-203192
Capacity	Rated power	10KVA	10KVA	15KVA	20KVA
	Peak power	30KVA	30KVA	45KVA	60KVA
Input	Standard battery voltage	48V	96V	192V	
	DC input voltage	42-60VDC@48V ; 84-120VDC@96V ; 168-240VDC@192V			
	AC input voltage	165-265VAC		175-270VAC	
	AC input frequency	50/60Hz±5Hz			
Protection	Battery low pressure warning	42-60VDC@48V ; 84-120VDC@96V ; 168-240VDC@192V			
	Battery high voltage protection	68VDC@48V ; 136VDC@96V ; 272VDC@192V			
	Overload, high temperature, short circuit protection	Automatic shut-down			
Output	Effectiveness	≥90%			
	Output voltage	(DC Battery mode) 220VAC±3%			
	Output frequency	(DC Battery mode) 50Hz±0.5Hz			
	Output waveform	Pure sine wave			
	AVR output regulator	Output 220VAC±10%			
	AVR output frequency	Tracking the mains			
Other	Switth time	≤5ms			
	System language	Chinese / English (optional)			
	Display	LCD display			
	Cooling system	Forced air cooling, intelligent speed regulation			
	Operating mode	AC input priority/Battery Priority/ECO mode/Generator mode/Unattended mode			
	Communication	RS-485(Connectable remote panel)			
AC charging	Type of battery	SLA Battery/AGM Battery/Gel Battery/Li-ion & Customize			
	AC charging current	0-35A	10A	10A	
Working Environment	Temperature	0~55°C			
	Humidity	0~95% ( No condensation )			
Exterior	Product size (mm)	540X300X663		680X385X870	
	N.W ( kg )	60		110	130